



Wood ceilings & coverings

MICRO PLUS 250

invisible

microperforation

ø 0.5 mm



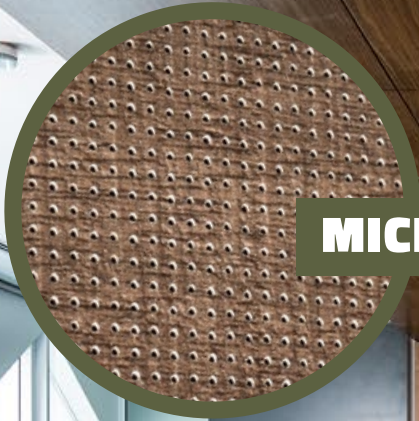

MICRO PLUS 250



MICRO PLUS 250
invisible microperforation
wood concealed 200 system CWI 100% removable



MICRO PLUS 250: invisible drilling, excellent performance.

The **MICRO PLUS 250** acoustic panel by CBI Europe combines the sound absorption of the superficial microperforation - invisible at a normal distance, and therefore it doesn't seem perforated - with that of the acoustic chamber created by the underlying holes of the MDF body.

The result is an innovative panel, with a contemporary mood, which allows you to create perceptually continuous and uniform coatings without sacrificing effective control of the acoustic correction.

The surfaces thus maintain unchanged in all their naturalness - materiality, veins, shades of tones - allowing designers to create extremely comfortable and welcoming environments with a modern and natural look.

The technology used for the microperforation allows an extraordinary control of the result, guaranteeing uniformity both in the size and in the distribution of the individual holes, and can be made both for panels with melamine coating and for those veneered in natural wood essences.

- + HI-TECH SOUND ABSORPTION
- + CONTEMPORARY AESTHETICS
- + DESIGN VERSATILITY
- + HYGIENE AND COMFORT

› **ACOUSTICS** Perfect control of reverberation and environmental noises thanks to the combination of surface and structural microperforation of the panel's body.

› **AESTHETICS** Perceptually continuous surfaces, which enhance the materiality and warmth of wood, for the creation of contemporary, elegant and welcoming environments.

› **DESIGN VERSATILITY** The Micro Plus 250 panel can be used with CBI Europe's structures - ceilings and walls - for the solution of any design need.

› **HYGIENE** The microperforation reduces the accumulation of dust or other impurities, guaranteeing healthy and comfortable environments in favor of well-being and productivity.

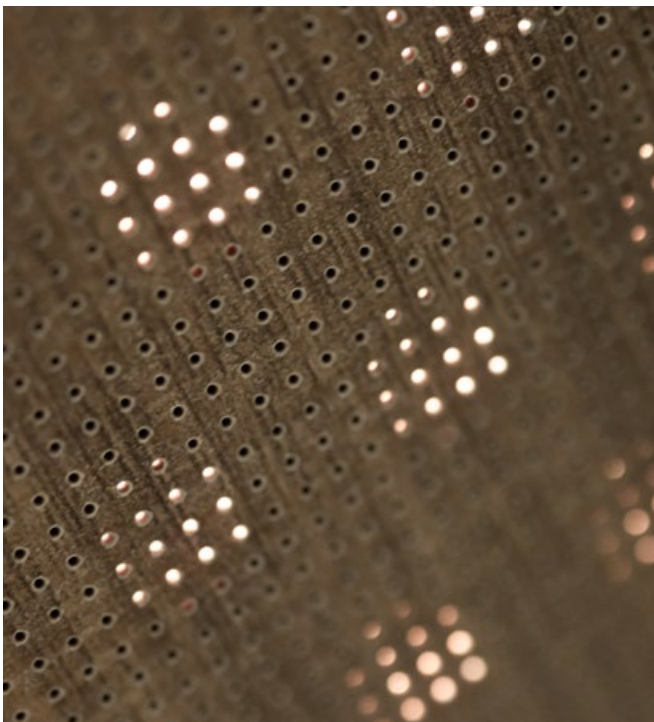

Details of the MICRO PLUS 250 microperforation on a panel with melamine coating.

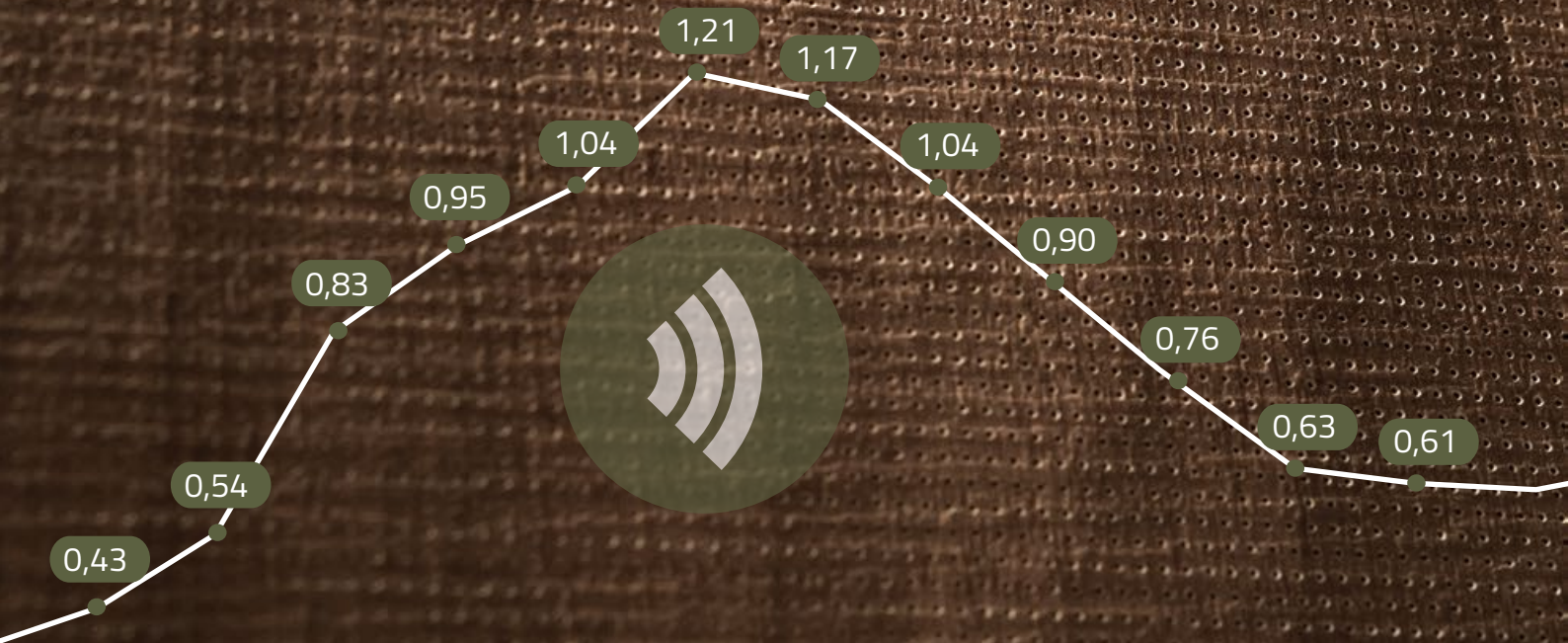

MICRO PLUS 250



250.000 holes/m²

high density MDF panel —○
sound absorbing fabric —○

microperforation on:
/ melamine faced chipboard
/ wood veneer

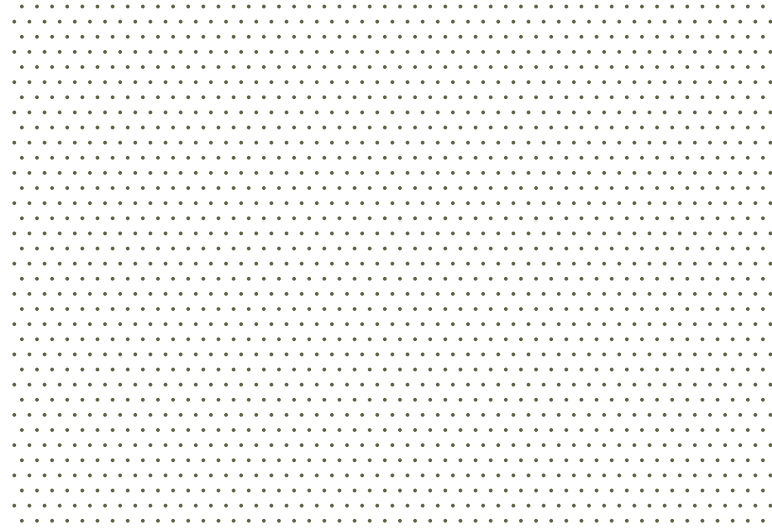
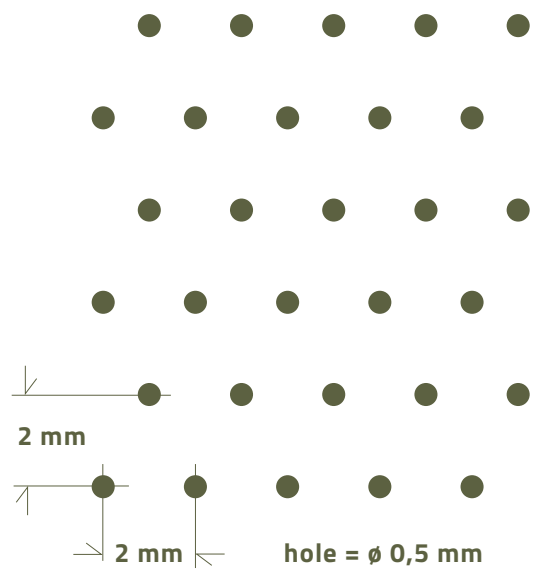

real size of the microperforation

WOOD EXPO 100 SYSTEM

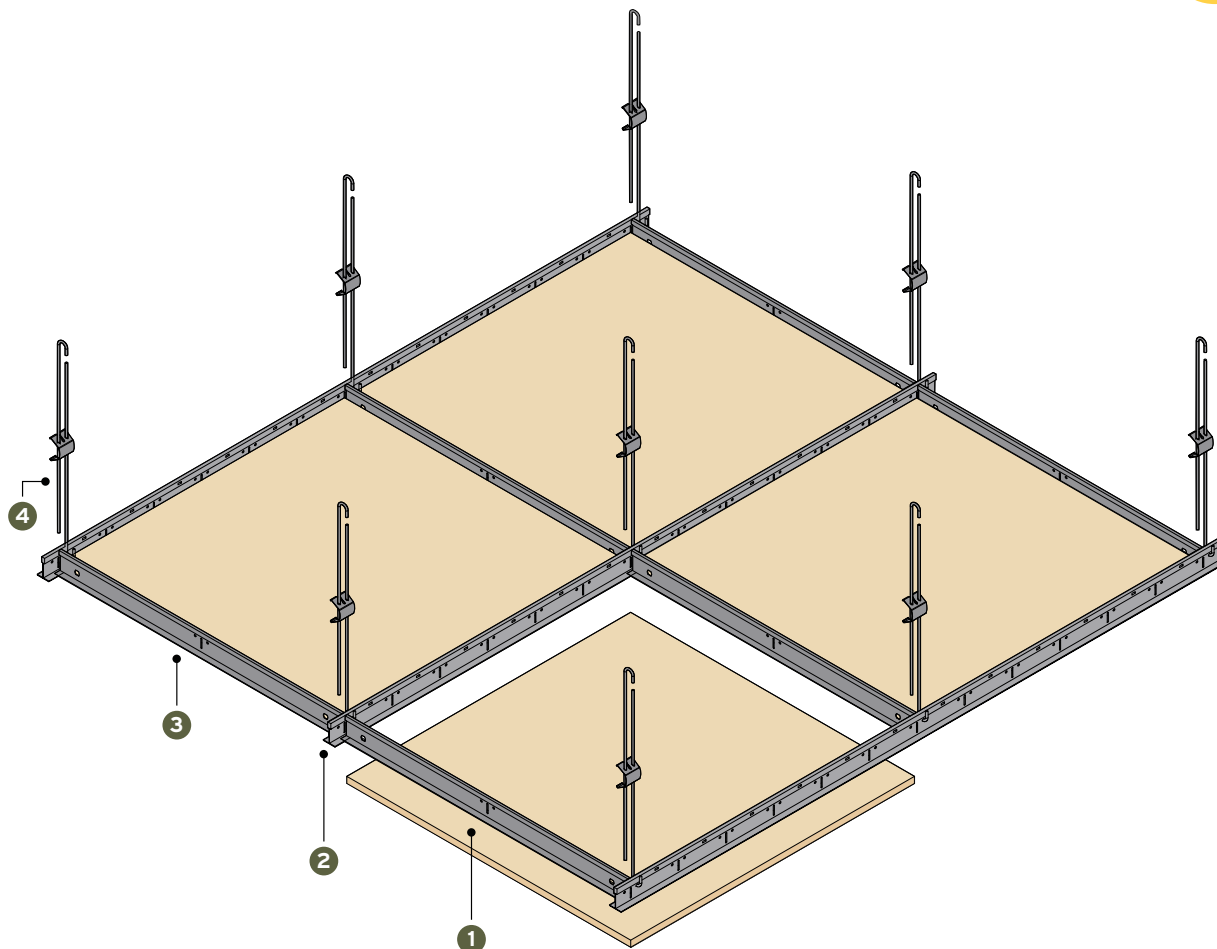

PANEL PANNELLO

dimension type
 square quadrato · MICRO PLUS 250
 rectangular rettangolare

GRID SYSTEM STRUTTURA

- CWT
- CWR
- CWN
- CWX

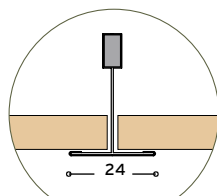

TRIM T24 > CWT

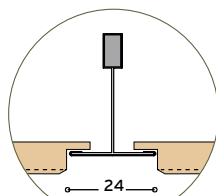

REVEAL T24 > CWR

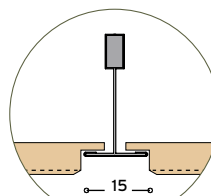

NARROW T15 > CWN

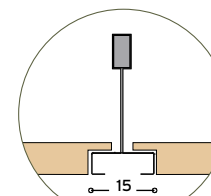

XLINE T15 > CWX

38

1	2	3	4
panel pannello 600x600 mm 600x1200 mm	main runner profilo portante	cross tee profilo intermedio	SOR suspension sospensione
	CWT · CWR > PKH 3700 24x38x3700 mm	IKH 0600 24x38x600 mm	
	CWN > PKA 3700 15x38x3700 mm	IKHA 0600 24x38x600 mm	
	CWX > BP 3600 15x42x3600 mm	BP 0600 15x42x600 mm	

WOOD CONCEALED 200 SYSTEM

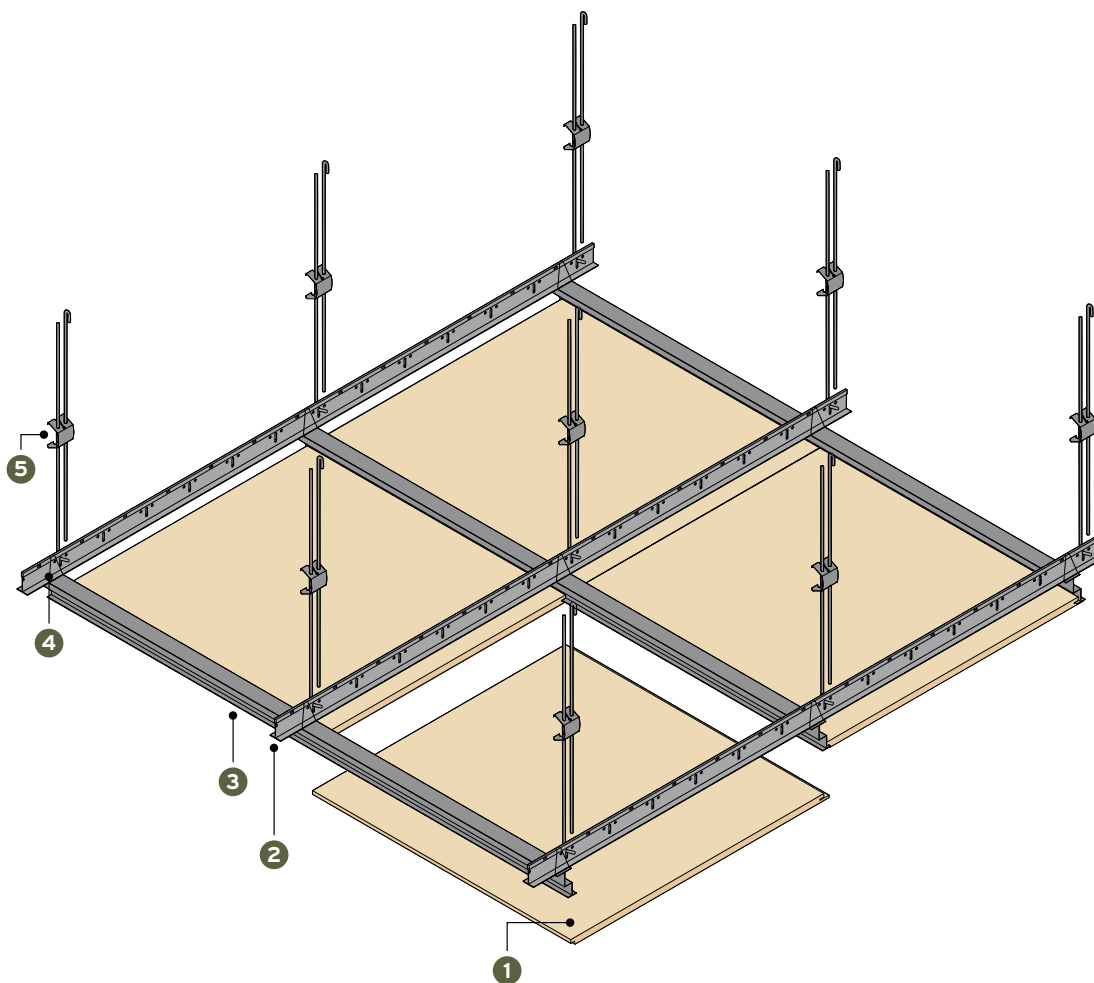

PANEL PANNELLO

dimension type
 square quadrato · MICRO PLUS 250
 rectangular rettangolare

GRID SYSTEM STRUTTURA

· CWI

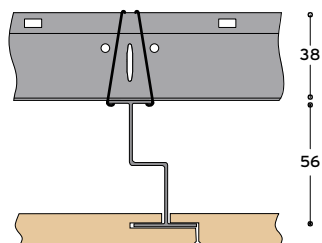

1	2	3	4	5
panel pannello 600x600 mm 600x1200 mm	P 3700 Z main runner profilo portante 24x38x3700 mm	Z 4000 W secondary profile profilo secondario 24x56x4000 mm	SP 38.1 cross connector raccordo ortogonale	SOR suspension sospensione

WOOD CONCEALED 200 SYSTEM **accessible**



**INSPECTABLE
WITH TRAPDOOR**
ISPEZIONABILE
CON BOTOLA

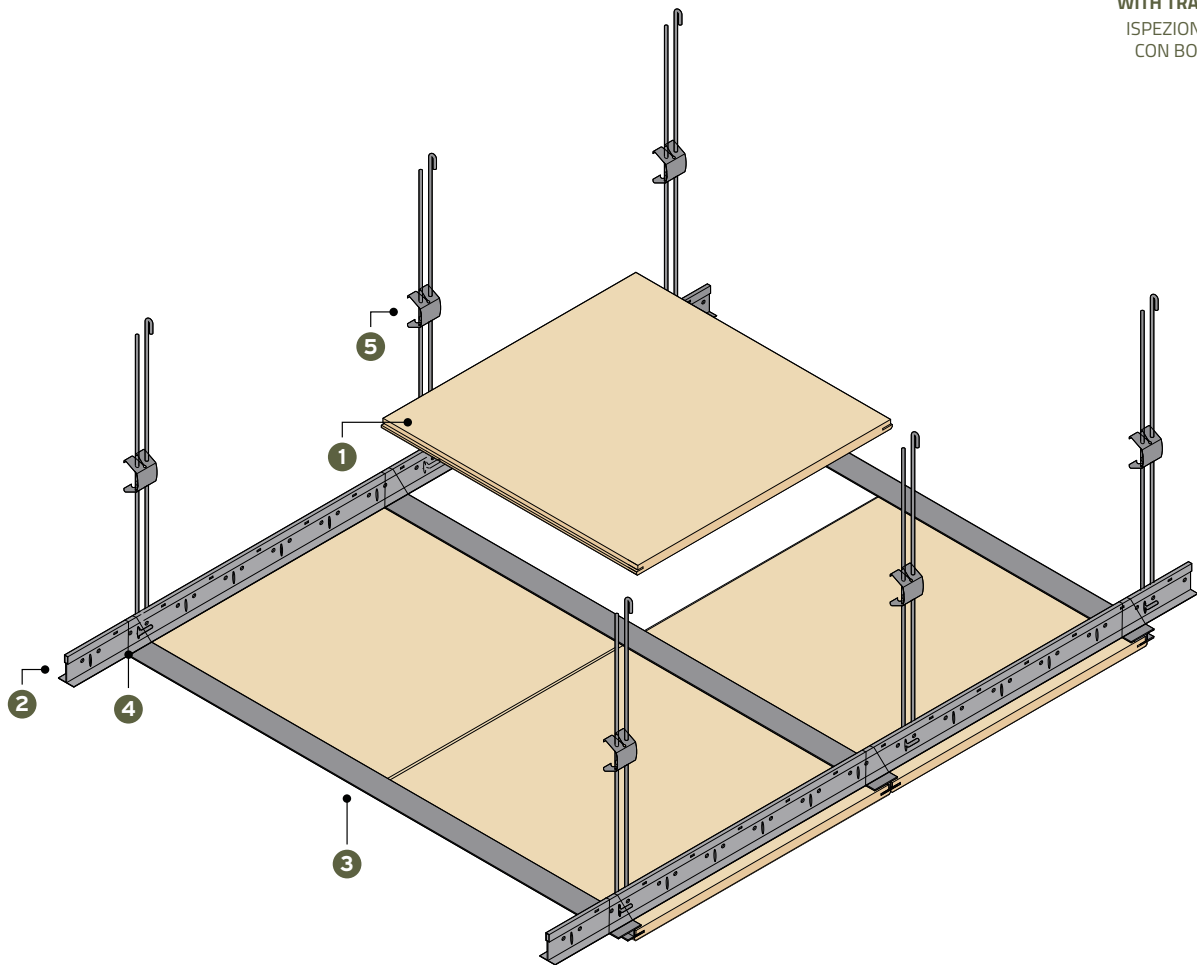

PANEL PANNELLO

dimension type
square quadrato · MICRO PLUS 250
rectangular rettangolare

GRID SYSTEM STRUTTURA

· CWA

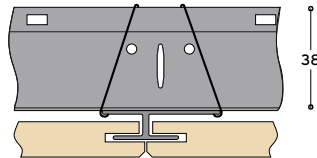

1	2	3	4	5
panel pannello 600x600 mm 600x1200 mm	P 3700 Z main runner profilo portante 24x38x3700 mm	PP 1001 secondary profile profilo secondario 36,5x12x4000 mm	SP 38.1 cross connector raccordo ortogonale	SOR suspension sospensione

WOOD CONCEALED 200 CWI SYSTEM

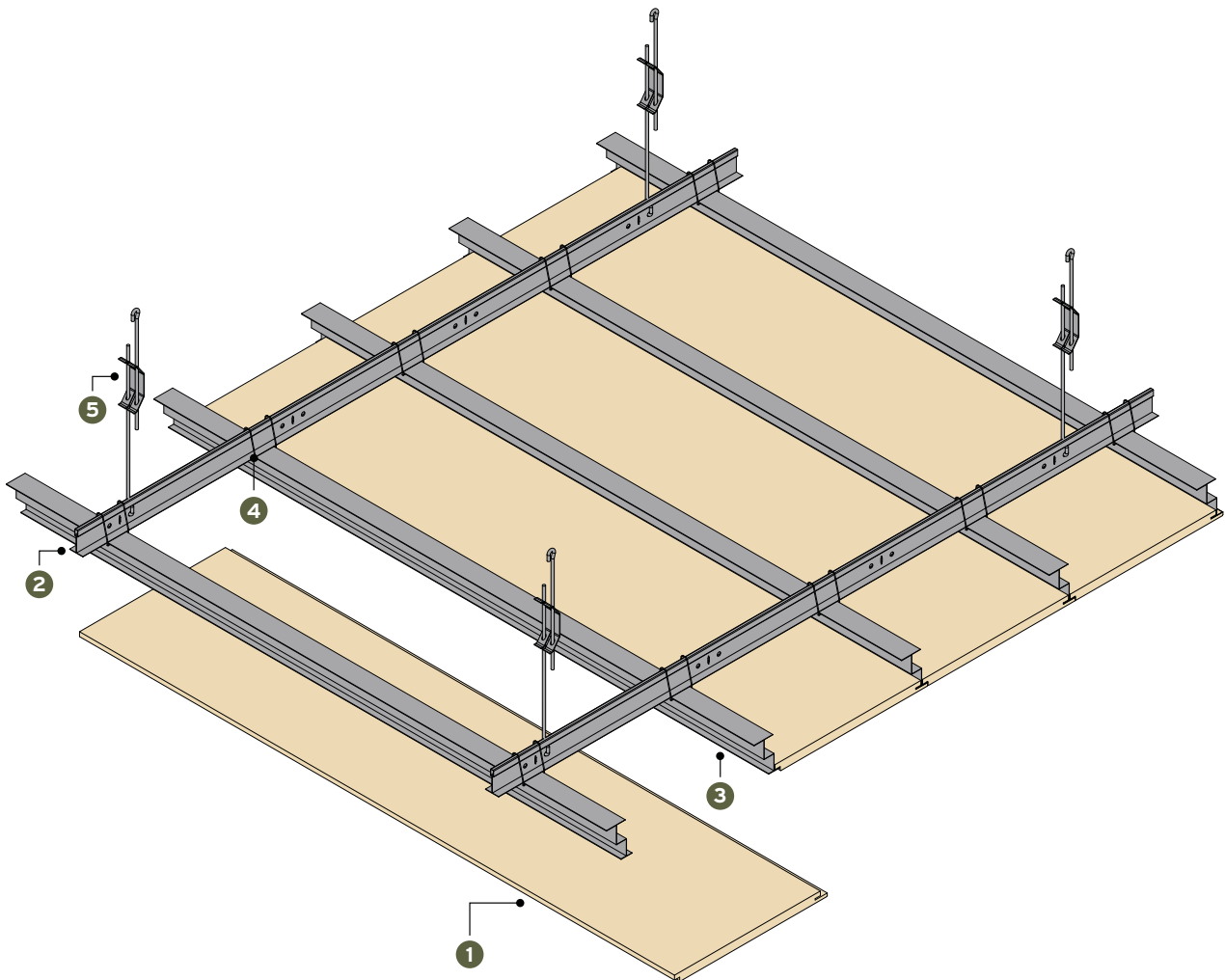

PANEL PANNELLO

dimension type
 square quadrato · MICRO PLUS 250
 rectangular rettangolare

GRID SYSTEM STRUTTURA

· CWI

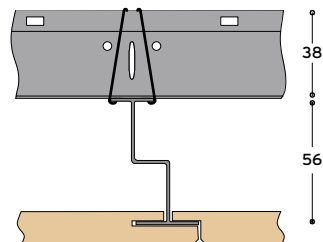

1	2	3	4	5
panel pannello 600x600/1200 256x1792	P 3700 Z main runner profilo portante 24x38x3700 mm	PP 1001 secondary profile profilo secondario 36,5x12x4000 mm	SP 38.1 cross connector raccordo ortogonale	SOR suspension sospensione

WOOD CONCEALED 400 SYSTEM

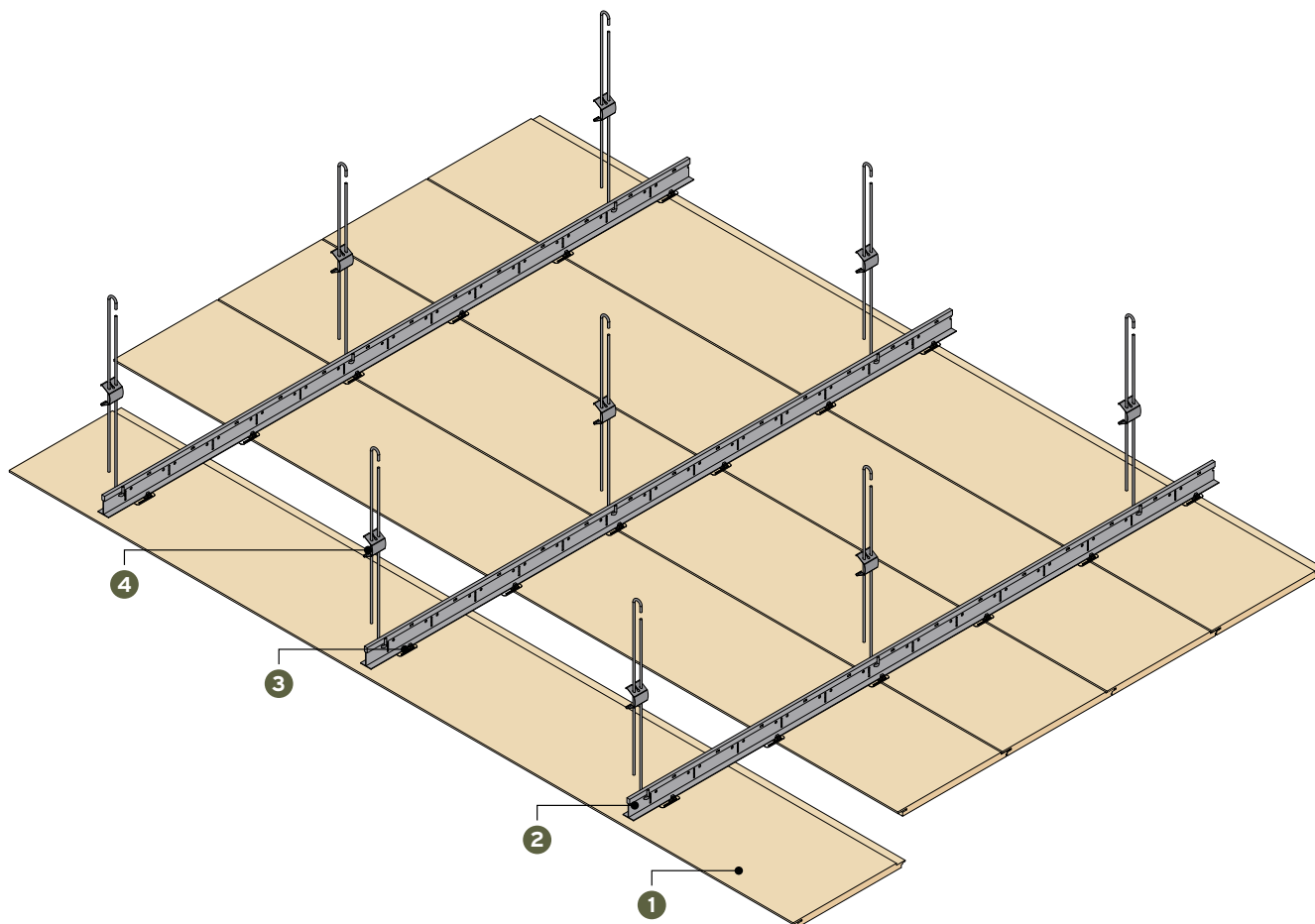

PANEL PANNELLO

dimension type
 rectangular rettangolare · MICRO PLUS 250

GRID SYSTEM STRUTTURA

· CWB

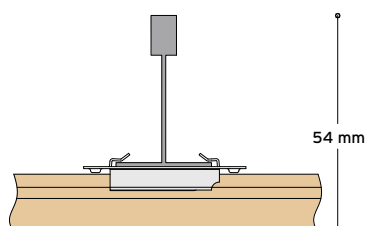

1

panel
 pannello

2

P 3700 Z main runner
 profilo portante
 24x38x3700 mm

3

SP76 hidden suspension hook
 gancio di sospensione nascosto

4

SOR suspension
 sospensione

WOOD CONCEALED 401 SYSTEM

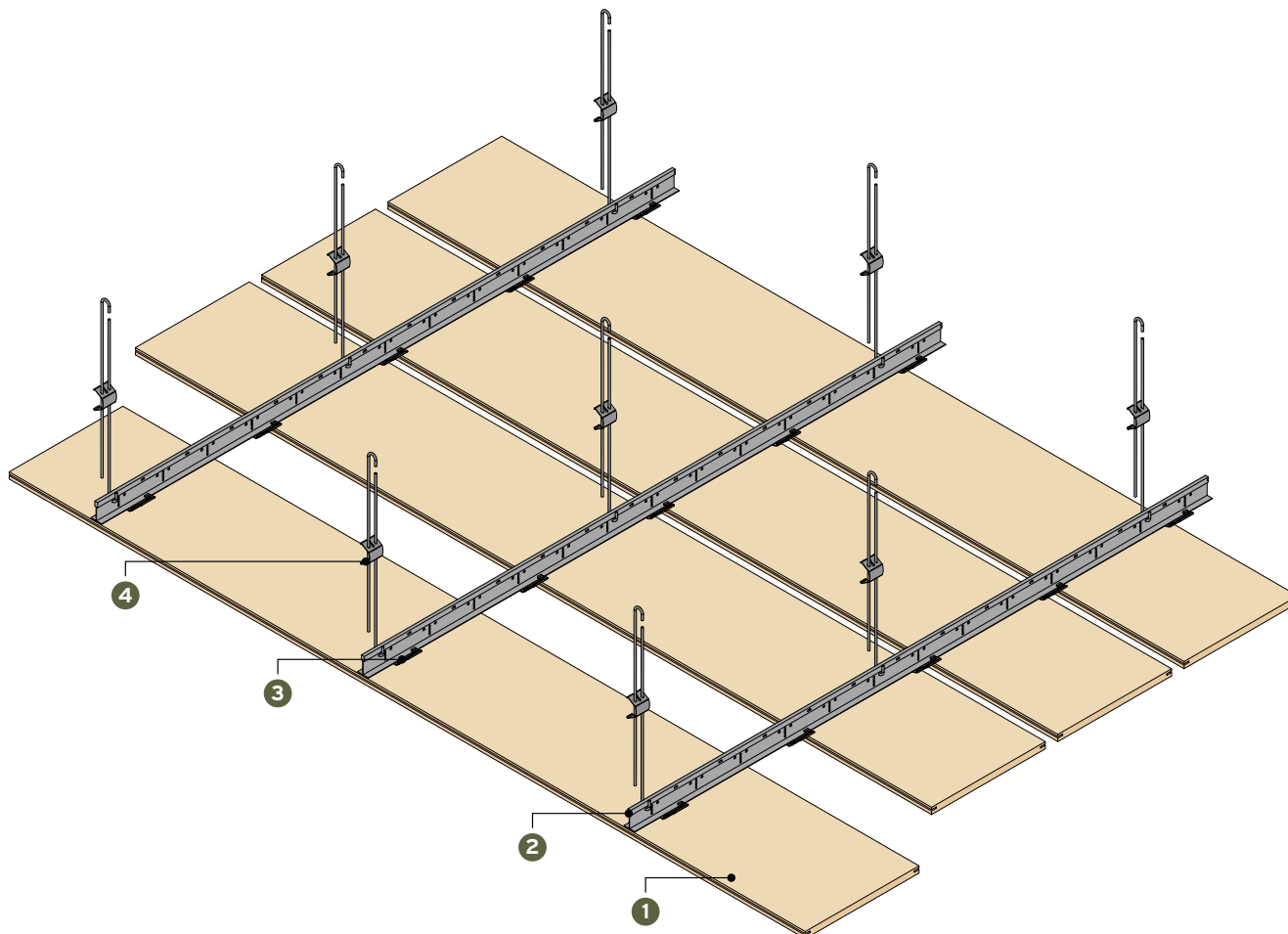

PANEL PANNELLO

dimension type
 rectangular rettangolare · MICRO PLUS 250

GRID SYSTEM STRUTTURA

· CWC

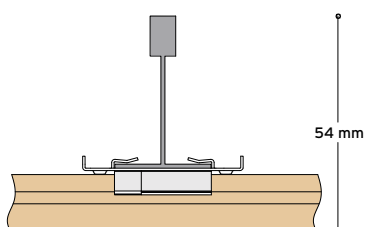

1	2	3	4
panel pannello	P 3700 Z main runner profilo portante 24x38x3700 mm	SP 78 spacer hook gancio distanziale gap fuga 20 mm	SOR suspension sospensione

WOOD COVERING 500 SYSTEM



EASY INSPECT



CUSTOM SIZE

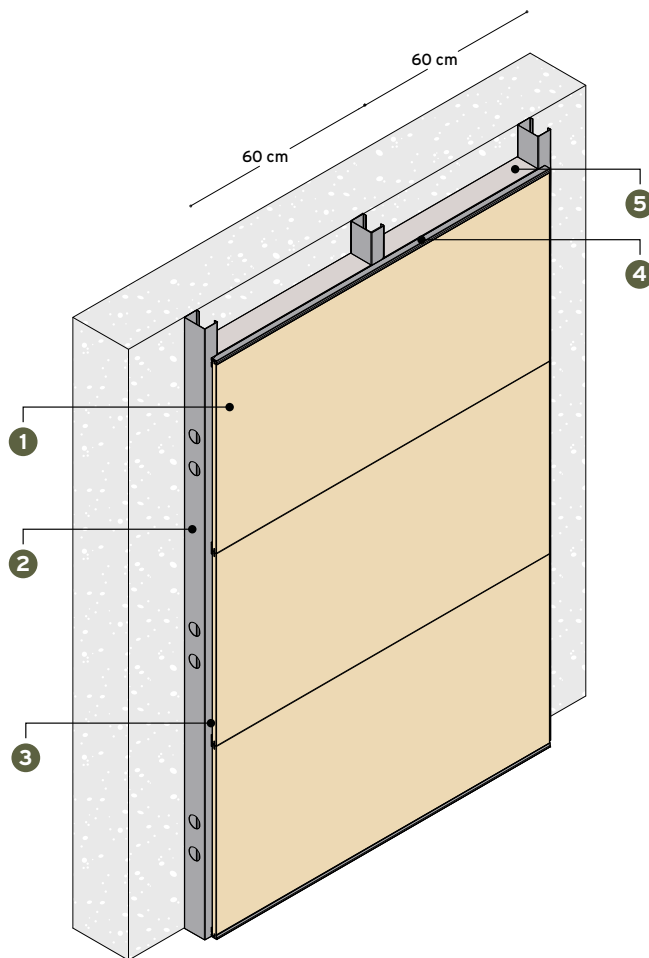

PANEL PANNELLO

dimension type
 square quadrato · MICRO PLUS 250
 rectangular rettangolare

custom su misura

GRID SYSTEM STRUTTURA

· WC1

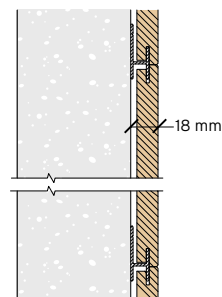
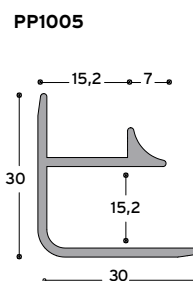
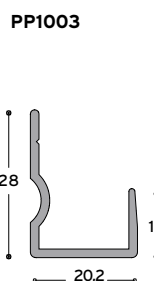
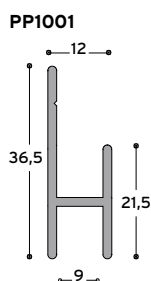

1	2	3	4	5
panel pannello	M46 / 75 primary support structure struttura di sostegno primaria	PP1001 Acoustik Plus Sherwood PP1001.N Sound Wood secondary profile profilo secondario	PP1002 Acoustik Plus PP1003 Sherwood Sound Wood starting profile profilo di partenza	PPN1 / 40.1 rockwool insulation lana di roccia 600 x 1200 mm

WOOD COVERING 501 SYSTEM



EASY INSPECT



CUSTOM SIZE

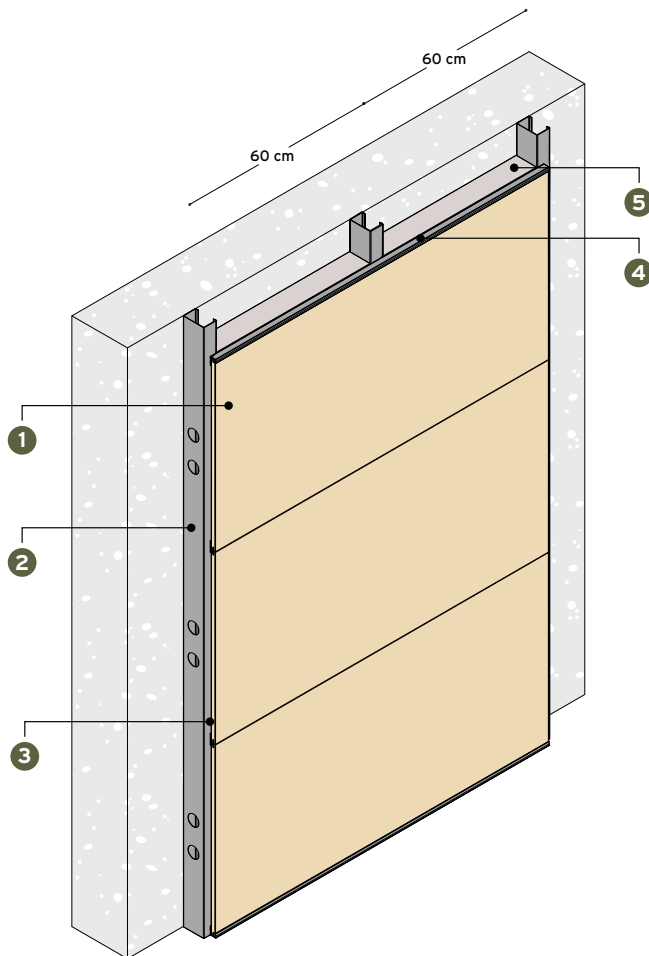

PANEL PANNELLO

dimension type
 square quadrato · MICRO PLUS 250
 rectangular rettangolare

custom su misura

GRID SYSTEM STRUTTURA

· WC6

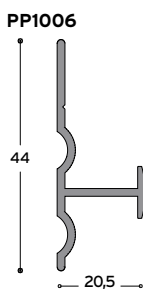

PP1003

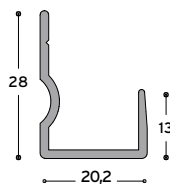

PP1005

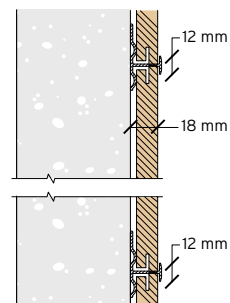
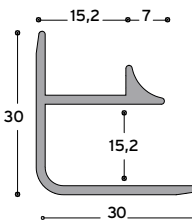

1

panel
 pannello

2

M46 / 75 primary support
 structure
 struttura di sostegno
 primaria

3

PP1006 secondary profile
 profilo secondario

4

PP1002 Acoustik Plus
PP1003 Sherwood Sound Wood
 starting profile
 profilo di partenza

5

PPN1 / 40.1 rockwool insulation
 lana di roccia
 600 x 1200 mm

WOOD COVERING 502 SYSTEM



EASY INSPECT



CUSTOM SIZE

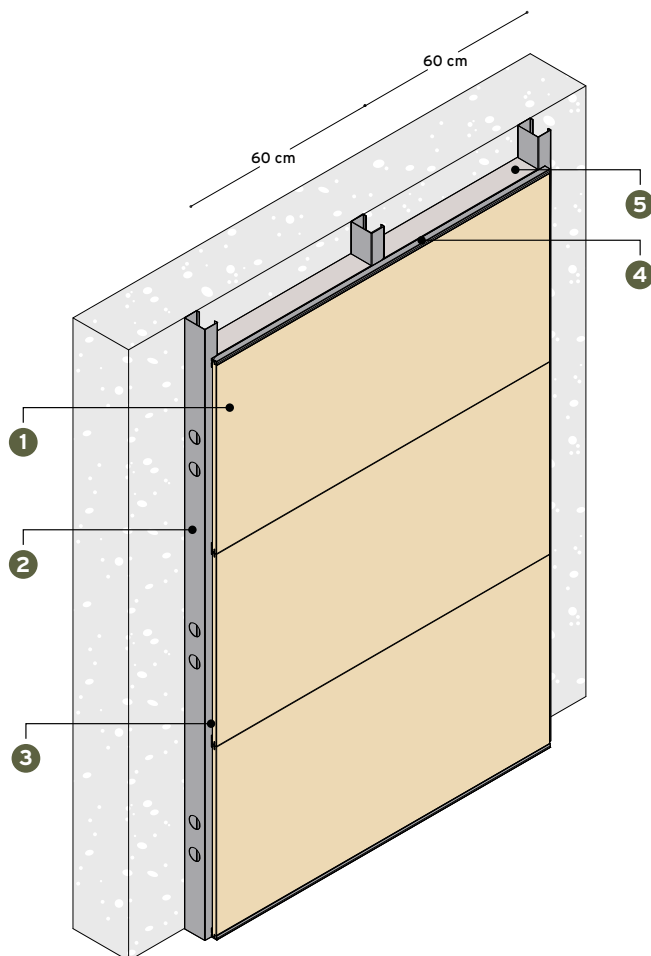

PANEL PANNELLO

dimension type
 square quadrato · MICRO PLUS 250
 rectangular rettangolare

custom su misura

GRID SYSTEM STRUTTURA

· WC7

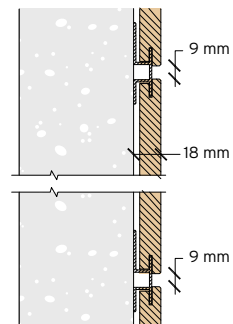
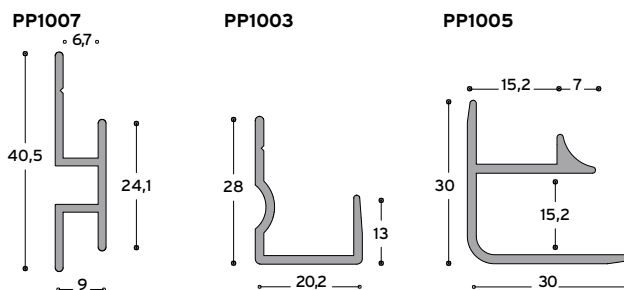

1

2

3

4

5

panel pannello	M46 / 75	primary support structure struttura di sostegno primaria	PP1007	secondary profile profilo secondario	PP1002 Acoustik Plus PP1003 Sherwood Sound Wood	starting profile profilo di partenza	PPN1 / 40.1	rockwool insulation lana di roccia 600 x 1200 mm
----------------	-----------------	--	---------------	--------------------------------------	--	--------------------------------------	--------------------	---

WOOD COVERING 503 SYSTEM



EASY INSPECT



CUSTOM SIZE

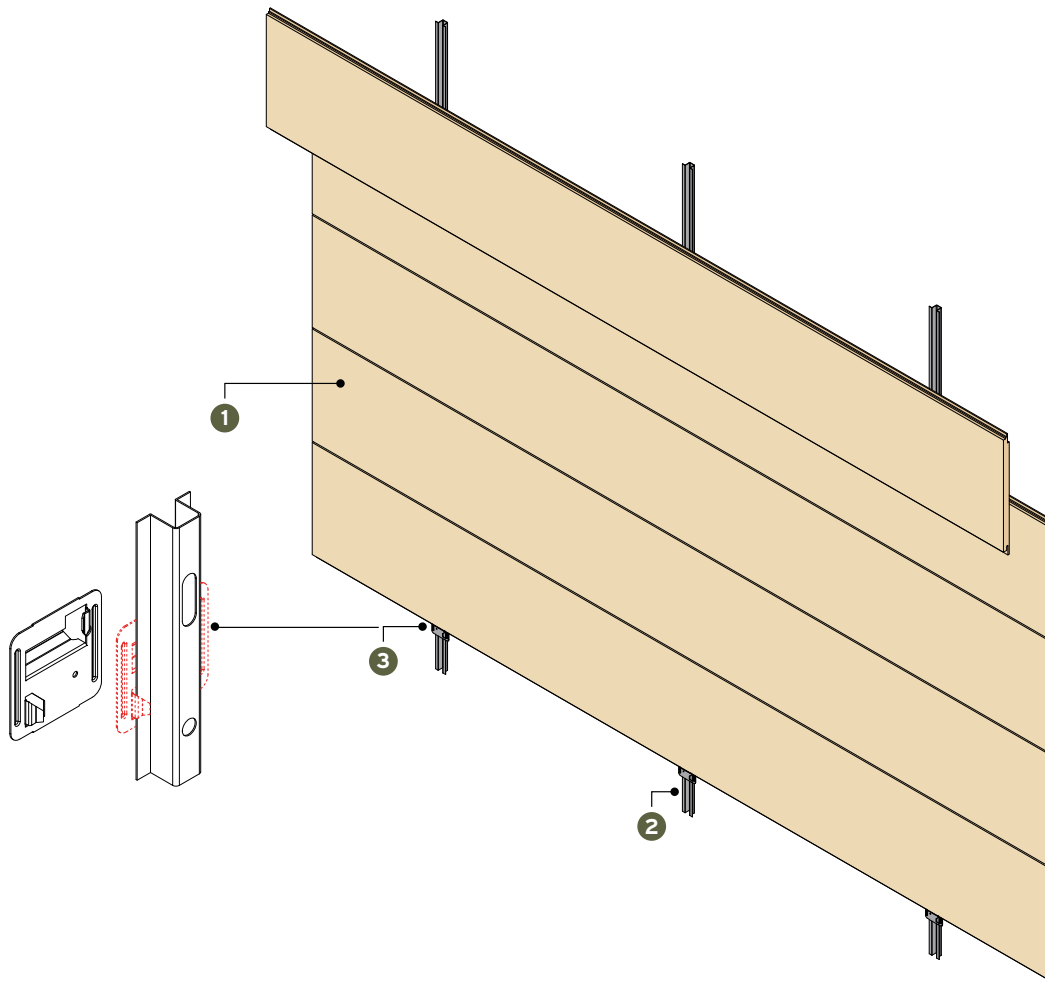

PANEL PANNELLO

dimension type
 square quadrato · MICRO PLUS 250
 rectangular rettangolare
 custom su progetto

GRID SYSTEM STRUTTURA

· WC2

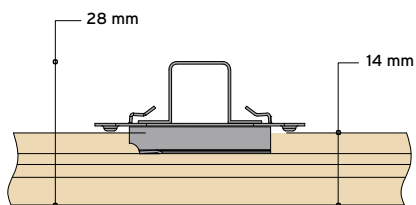

PP1003

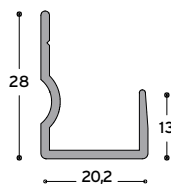

PP1005

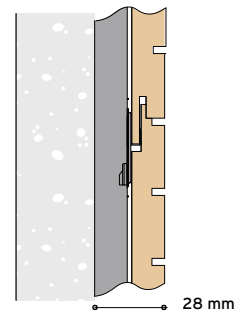
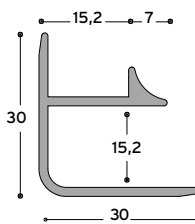

1

panel
 pannello

2

PP 1008

3

SP76 hidden suspension hook
 gancio di sospensione nascosto

PERIMETRAL MOLDING

WOOD EXPO 100

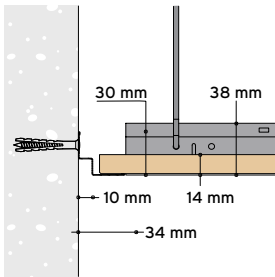

W3000
CWT

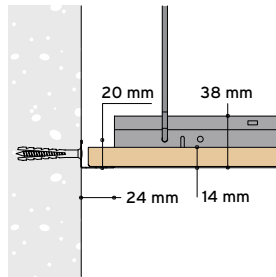

A3000
CWT

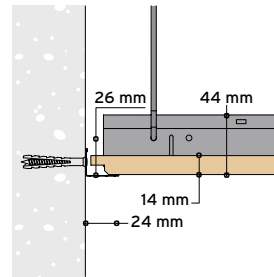

A3001
CWR · CWN

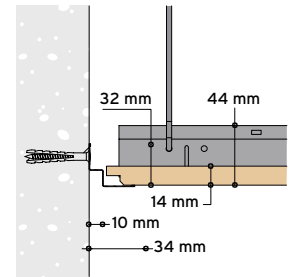

W3001
CWR · CWN

WOOD CONCEALED 200 SYSTEM

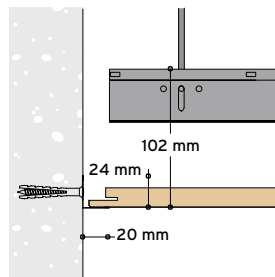

A3000
CWI

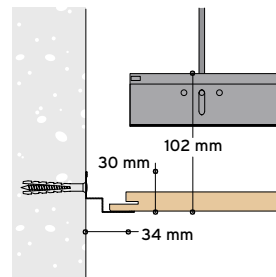

W3000
CWI

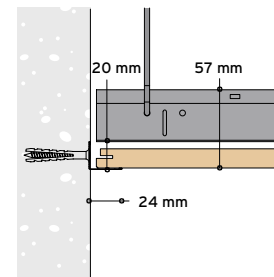

A3001
CWA

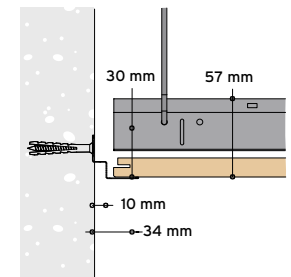

W3000
CWA

WOOD CONCEALED 400 / 401 SYSTEM

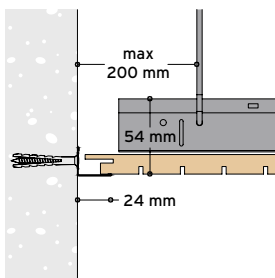

CWB · CWC
A3001

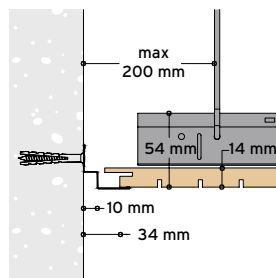

CWB · CWC
W3000

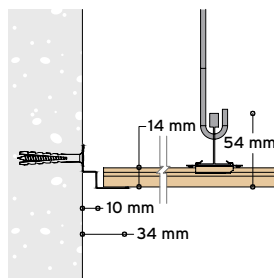

CWB · CWC
W3000

WOOD COVERING 500 / 501 / 502 / 503 SYSTEM

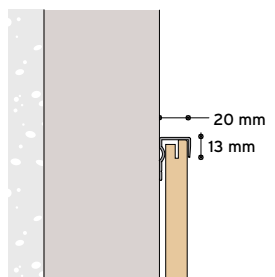

WC1 · WC2 · WC6 · WC7
PP1002 · PP1003

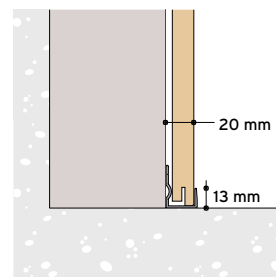

WC1 · WC2 · WC6 · WC7
PP1002 · PP1003

FINISHES

MELAMINE

> MICRO PLUS 250 · SHERWOOD · SOUND WOOD · LAMELLA



oak rock white



elm tafira



ash tree supremo



oak bruges



walnut athens

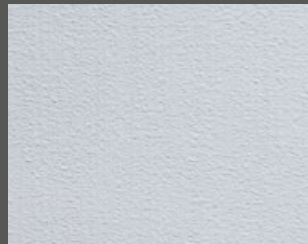

white

REAL VENEER

> MICRO PLUS 250 · SHERWOOD · ACOUSTIK PLUS · SOUND WOOD · LAMELLA



maple

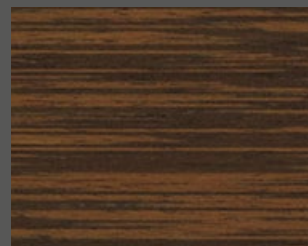

wengè



beech

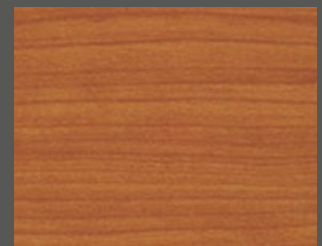

cherry



zebrano



ash tree



walnut 1



walnut 2

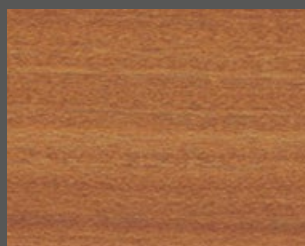

mahogany

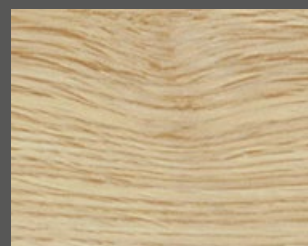

oak

The colour card shown on this page is purely for information purposes; please request samples. Please contact CBI Europe's Technical Office for special colour

requirements which will be supplied only for orders of at least 800 sq.m. Wood system accessories are finished in aluminium or wood.

ACCESSORIES

HOLES FOR LIGHTING UNITS

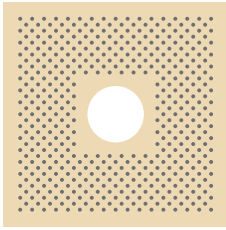

H01

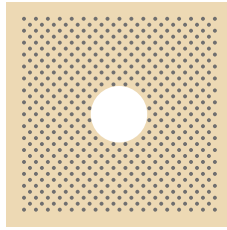

H02

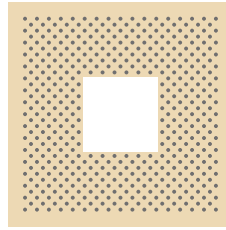

H03

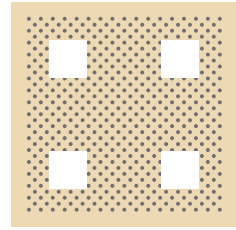

H04

AIR VENTS

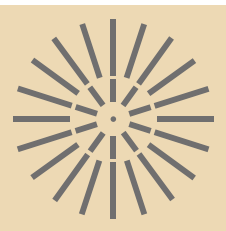

H05

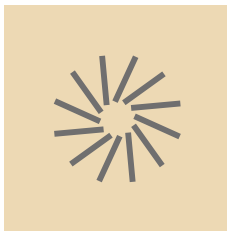

H06

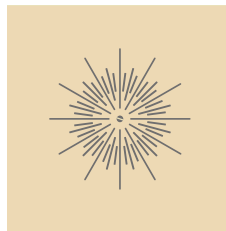

H07

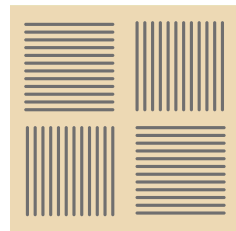

H08

FITTINGS

All Wood System panels permit the installation of fittings such as lighting, air nozzles, fume detectors, sprinklers and suspended signboards.

WOOD CEILINGS & COVERINGS: technical perfection, 100% made in Italy.

Modern, welcoming workplaces, free from noise pollution, where the warmth of natural wood is complemented by stylish, clean lines. Slats and panels set new standards in style for public offices and community spaces.

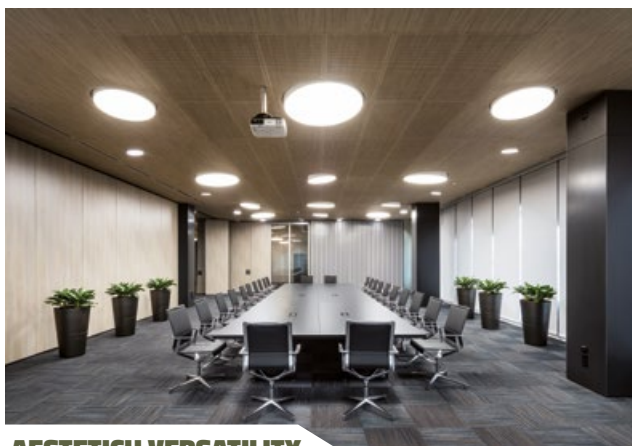

AESTETICH VERSATILITY

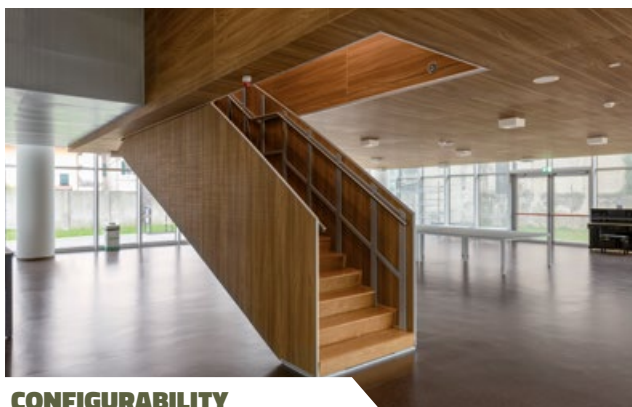

CONFIGURABILITY

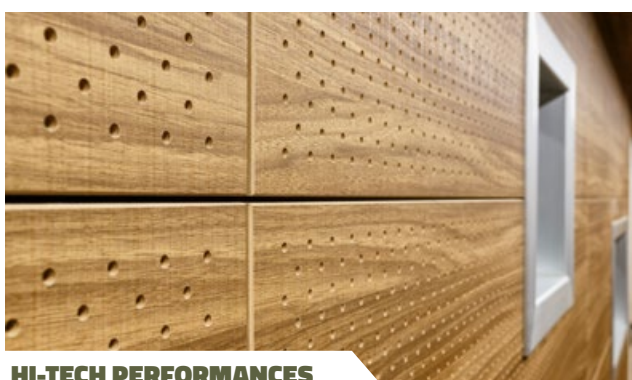

HI-TECH PERFORMANCES

Modular elements standard or custom made, resistant, durable, easy to handle, simple and quick to install, inspected, certified, eco-friendly. They can be installed in any environment thanks to the architectural elements of great aesthetic versatility.

Why

- **MODERN AESTHETICS FOR ENVIRONMENTS WITH A WELCOMING AND NATURAL ATMOSPHERE.**
- **EXCLUSIVE IN-LINE ASSEMBLY STRUCTURE: SIMPLE, QUICK TO INSTALL, WITH CUSTOMIZABLE GAP ON REQUEST.**
- **SEISMIC SAFETY.**

Where

AUDITORIUMS, THEATRES, AIRPORTS, CONFERENCE ROOMS, OFFICES, PUBLIC SPACES AND ALL ENVIRONMENTS THAT REQUIRE SAFETY, EFFECTIVE NOISE CONTROL AND ELEGANT INTERIOR DESIGN.

Benefit

- **ACHIEVING FLEXIBLE, COMFORTABLE, CONTEMPORARY AND RESPONSIBLE INTERIORS.**
- **OBTAINING POINTS FOR LEED CERTIFICATION.**
- **SOUNDPROOFED ENVIRONMENTS.**
- **SPEEDING UP CONSTRUCTION.**
- **CONTAINING COSTS OF LABOUR AND MAINTENANCE.**
- **STRUCTURES 100% INSPECTABLE.**
- **INTEGRATION WITH ADVANCED CLIMATE CONTROL, DOMOTICS AND LIGHTING.**
- **PRECISE BUDGETING.**



FIRE REACTION

CBI Europe works hard to ensure the safety of the environments set up with its products. Research and tests allow us to obtain a constant evolution of quality. Certifications are provided on request.



FASTNESS

Our systems are designed to guarantee rapid installation, speeding up the laying phases and respecting all the requirements of planarity and orthogonality.



ACOUSTIC ABSORPTION

All systems are designed to offer excellent sound absorption performance, specific to the type of environment, safety and aesthetic results. Certifications are provided on request.



LEED CERTIFICATION

All products are manufactured in certified and constantly monitored processes to guarantee the highest standards of quality and safety.



ANTI-SEISMIC

The systems guarantee the application of all good safety practices in the construction and development of dedicated projects. Upon request, they can be supplied with an anti-seismic reports, which indicate suitable bracing.



INTEGRATED ACCESSORIES

The system can be fitted with accessories such as lighting units, ventilation vents, smoke detectors, sprinklers and suspended signage.



RECOMMENDATIONS FOR INSTALLATION

Slight differences in colour and shade between one panel and another are due to natural variations in the wood veneers. To obtain the most pleasing aesthetic effect, we recommend that you lay the panels out before deciding on their final arrangement. It is also good idea to order an extra number of panels to allow for future replacements, since shades, colours and grain can vary from one batch to another. All 'CBI Sound Wood Panels' must only be installed in indoor environments when the building maintained at a constant temperature.

Wood System panels should be removed from their packaging in the place of installation 48 hours before installing the ceiling or wall, so that they can assume the humidity of the environment. We recommend switching on the air conditioning in the environment at least 24 hours before starting installation. The installation environment should have temperature no lower than 15° and a relative humidity between 35% and 55% before work starts.



HYGIENE AND MAINTENANCE

Wood System panels are easy to maintain and require no special maintenance. To clean, simply wipe with a dry cloth. Panels should not be exposed to direct sunlight: like all natural materials, wood tends to change colour when exposed to UV rays. The polyacrylate treatment of the panels tends to reduce this effect. Remember that water and humidity will damage the veneering.



CBI EUROPE Via Mons. A.O. Romero, 14 · 60027 Osimo (AN) Italy
T +39 071 71 08 688 · fax +39 071 71 08 63 · info@cbi-europe.com · www.cbi-europe.com

